



PRODUCT BROCHURE

commtel.io



DEFINED BY
CONNECTION.
Dedicated to support.

Introduction	4
The Commtel Difference	6
Resource HUB	8
Features	10
Dimensions	12
IP Intercoms	14
NX1	16
NX250	17
4G Intercoms	18
SOLO	18
SOLO+	19
DUO+	20
TRIO+	21
JUNIOR	22
VARIO	23
MILLENNIUM	24
VISION	25
SENIOR	26
HUBS & SATELLITES	28
Access Control	30
TELPAD II	30
COMMAND UNIT	31
SIM Cards	32
Product Matrix	34
Custom Solutions	38
Apps	40
Our History	42

INTRODUCTION

For over 30 years, we've been building intercoms with a steadfast focus on what matters most: **You, our customer.**

We've continually grown by staying close to what the industry's needs are – providing reliable, high-quality products that installers and end-users can count on. Our products are designed and built right here in the UK, a testament to our commitment to solutions of enduring quality.

We see our role as more than a supplier.

We are a dedicated partner, wholly invested in your success. That's why our systems are designed for straightforward installation and operation, backed by the comprehensive support you need, from your initial inquiry to your project completion.

With Commtel, you gain a partner you can depend on. We are defined by connection, and dedicated to support.

So, why Commtel?

We understand the hard work and expertise that goes into every installation. The final step, the communication at the entrance.

Our purpose is to ensure that this is the most seamless and reliable part of the job. Our approach is to be **the trusted partner** who makes that final stage effortless, allowing installers to deliver a flawless finish every time.



THE COMMTEL DIFFERENCE

What truly sets us apart isn't just what we build, but how we build it, and the relationships we build along the way.

Our unique value is grounded in three core pillars that directly benefit our customers and define our commitment to your success:

Human-Centric Approach:

We firmly believe in the power of genuine connections, and we prioritise building and maintaining those strong relationships with our installers and partners.

By fostering open communication and providing personalised support, we aim to create a collaborative environment focused on joint success.

Future-Forward Expertise:

We understand the fundamentals of the market and are definitively positioned to maximise on future technologies, evolving with the market to provide solutions for our customers.

Unwavering Commitment:

We are driven to excel in every aspect of our business. From the quality of our products to the integrity of our practices, we hold ourselves to the highest standards.

This commitment ensures our customers can rely on us to deliver reliable, durable, and ethically sound solutions that last.

RESOURCE HUB

As part of our renewed focus on support and simplicity, we've created a dedicated Resource Hub; a single, central space designed to make your working life easier.

We know that reliable information is as vital as reliable products. From installation to everyday use, having the right documentation at hand ensures every Commtel system performs exactly as intended. The Resource Hub brings all our product knowledge together in one accessible place, giving you confidence that you're always working from the most accurate, up-to-date information.

You'll now have direct access to:

- **Installation Guides:** Step-by-step setup for each product (Requires you to be logged in on the website)
- **Specification Documents:** Detailed technical information
- **User Guides:** Clear instructions for day-to-day operation
- **App Guides:** Practical support for connected solutions

The Resource Hub is more than a library; it's part of how we're evolving as a company. It represents our promise to make quality not just something you can see and feel, but something you can depend on at every stage of your experience with Commtel.

Explore our Resource Hub



Whether you're specifying, installing, or maintaining a Commtel system, the Resource Hub keeps everything aligned to ensure that everyone involved can work from the same trusted source.

Click the icon on the right or visit: commtel.io/support/resource-hub

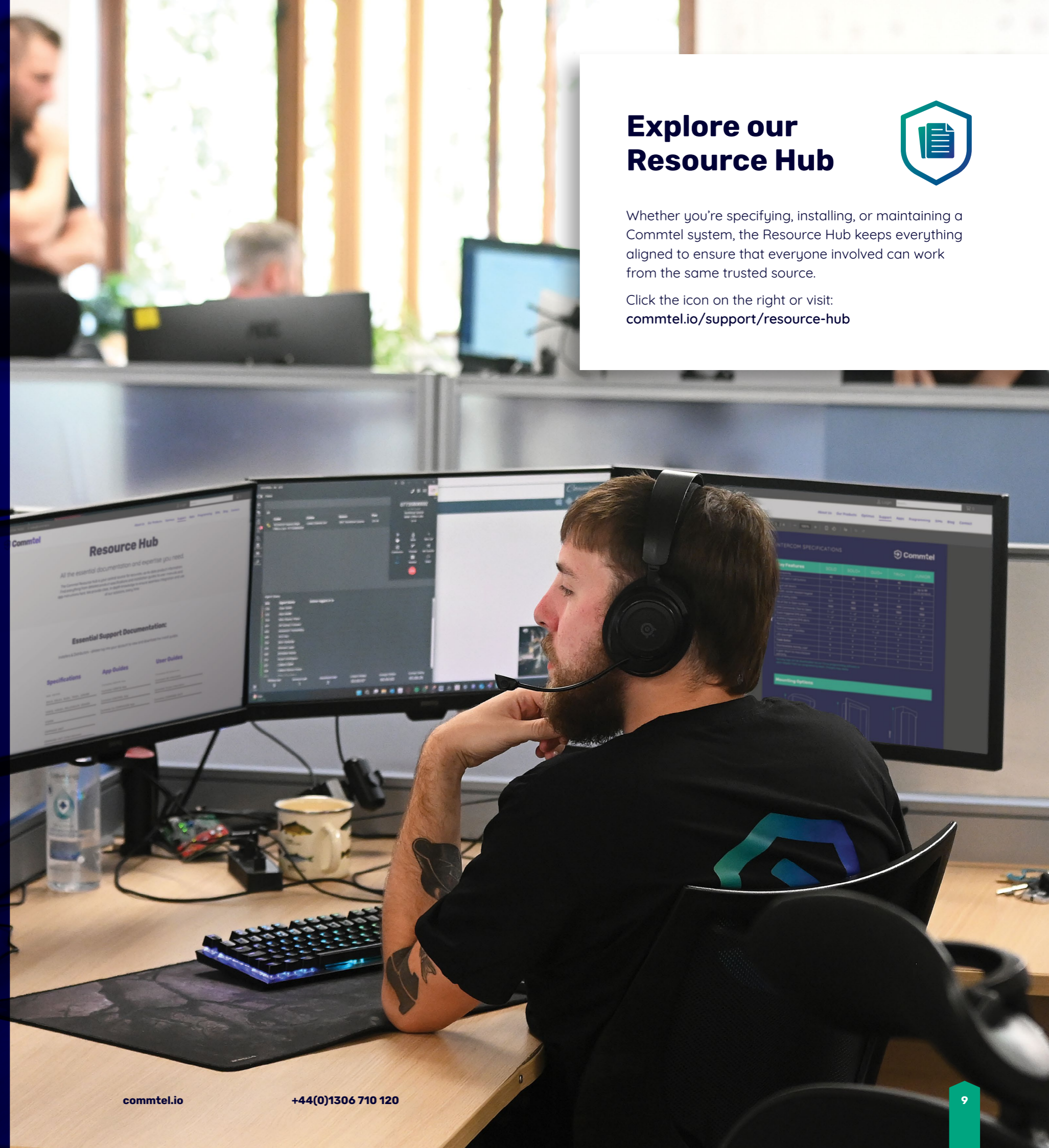

FEATURES

Our entry solutions are built to provide our customers with complete control, unwavering security, and seamless convenience.

Every feature, from flexible access management and remote programming to proactive monitoring and straightforward operation, has a single purpose: to serve you. We design our systems to meet the diverse needs of any application, ensuring you have a solution that is both powerful and intuitive.

For a comprehensive overview of our full product range, and to see how our features work in every system, please refer to our full product matrix on pages 34–37.



Controlled secure entry

Authorise, manage and control entry with ease and precision.

Keypad and Dial-to-Open enables control of access using the built-in keypad and up to 1300 dial-to-open numbers. Timed Access Restriction allows you to restrict entry for specific individuals by date, day of the week, or time using the on-board time clock.



Get Notified!

Event Notifications allow you to receive alerts when specific access codes are used or designated mobile numbers dial in.

Receive a notifications when connected equipment is used or if forced (depending on the type of equipment connected and how it's wired).

With SMS alerts you can notify customers of upcoming services or planned maintenance.



Information at Your Fingertips

Access essential resources and manage your Commtel account online.

Our website provides product guides and installation resources. Track programming changes, returns, and orders with ease. Find support through FAQs and troubleshooting tips. Trade customers can conveniently place orders online.*

*Install guides, return/order status tracking, and online ordering are available to installers only.



Security & Diagnostics

Ensure peace of mind with comprehensive continued monitoring and reporting.

All products feature a built-in Activity Log as standard, allowing remote diagnostics and enhancing security. Our dedicated technical support team can provide a copy of the activity log upon request.



Flexible Control & Support

Commtel offers user-friendly remote management and expert assistance.

Provide easy programming and control for installers via the Commtel CONFIG App and for end-users via the Commtel CONTROL App.

Our dedicated technical support team provides direct access to expert assistance when you need it most.



Flexible Time Management

Maximise control over access and operations with advanced time profiles.

Our on-board time clock offers extensive scheduling capabilities and automatic BST/GMT adjustment.

- Timed Relays
- Timed Access Allocation
- Timed Auxiliary Inputs
- Timed Call Diverts

DIMENSIONS

Commtel's commitment to providing tailored solutions extends beyond functionality to encompass design and integration.

Standard Back Boxes

We understand that the aesthetic appeal and physical fit of our products are crucial. Our products are designed for ease of installation under a range of back box options to suit various solutions:

- **Small Die-Cast Back Box:** Designed for our access control solution, TELPAD II, this back box provides a compact and discreet mounting solution.
- **Our standard Die-Cast Back Box:** Balancing a sleek profile with sufficient space for connections and mounting. This back box is used across our best selling products like the SOLO+ and JUNIOR.
- **The Large Die-Cast Back Box:** Our larger intercoms, such as the VARIO, MILLENNIUM and SENIOR feature an expanded back box designed to house additional buttons and an OLED display..

Customisation

For projects with unique aesthetic or installation demands, we offer extensive customisation options. From non-standard dimensions to bespoke finishes, we can work with you to create a solution that perfectly complements your project.

Contact our sales team to discuss your specific requirements and explore the possibilities for tailored solutions, call +44(0)1306 710120 - (Option 2) or email sales@commtel.io

Small cast
(40mm overall depth)

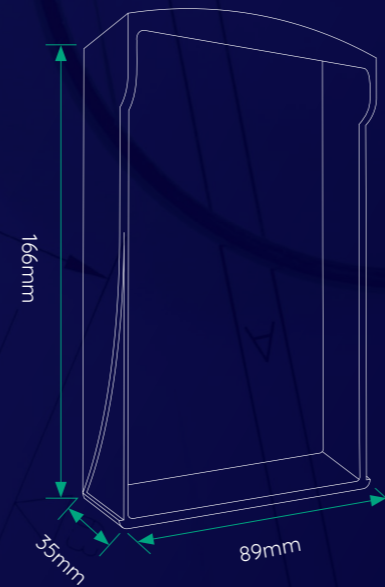

TELPAD II

Page 30

Standard cast
(40mm overall depth)

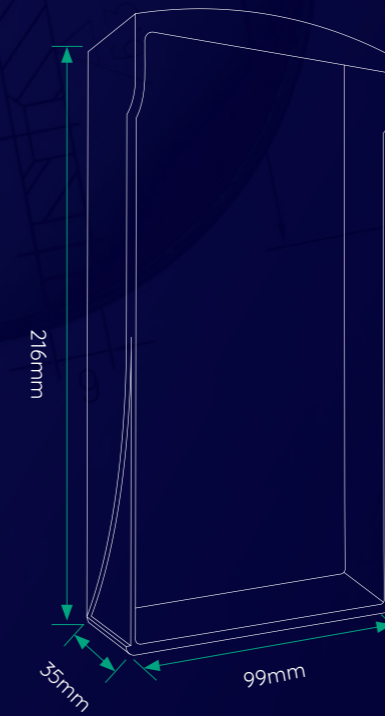

SOLO+

Page 19

Large cast
(40mm overall depth)

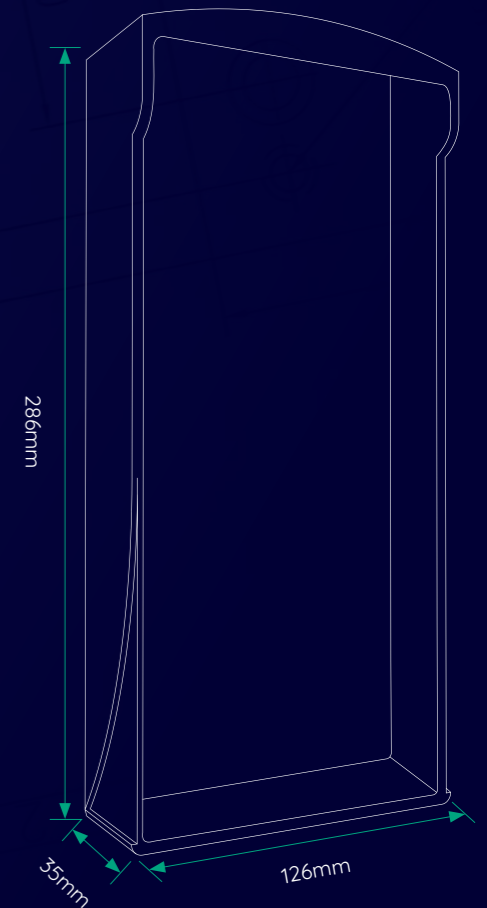

MILLENNIUM

Page 24

IP INTERCOM SOLUTIONS

Commтел's IP intercoms are a testament to our commitment to providing future-forward solutions that offer unparalleled clarity and connectivity.

While we've built our legacy on robust telecommunication networks, our NX1 and NX250 systems represent a new era of secure, scalable, and versatile entry.

Why IP Intercoms?

IP intercoms leverage the power of internet connectivity to deliver a modern, feature-rich experience.

Unlike traditional systems, they provide high-quality video, intuitive remote management, and a level of scalability that can adapt to sites of any size.

For distributors and installers, this means offering a solution that is both powerful and easy to integrate, meeting the demands of today's connected world and preparing for tomorrow's challenges.

The NX1 and NX250 models are built to provide state-of-the-art security solutions. The NX1 offers a powerful and compact solution, while the NX250 is designed for large-scale sites, handling up to 250 properties and 1,000 users with a simple, intuitive OLED directory. Both systems come with 4G and Ethernet as standard, ensuring reliable connectivity. Through the free Commтел NEXUS app, users can see, speak to, and grant access to visitors directly from their phone, offering a seamless and convenient experience.

To learn more about how Commтел's IP Intercoms can expand your offering and provide your customers with a cutting-edge solution, please contact our sales team on **+44(0)1306 710120** - (Option 2) or email sales@commтел.io.



NX250

NX1

Experience the difference that comes from a genuine partnership.

www.commtel.io

NX1



Faceplate Finish



BLACK

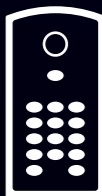

Click the icon to learn more about the NX1

The NX1 intercom from Commtel, marks a major step forward in delivering modern and advanced technology.

The NX1 comes with both Ethernet and 4G connectivity as standard, ensuring flexibility on any installation. With remote management through the Commtel NEXUS app, the NX1 provides a seamless and reliable experience for both installers and end-users.

Advanced Secure Entry

The NX1 ensures safe, controlled entry for homeowners, businesses, and site managers:

- **Dual Connectivity:** Choose between Ethernet or 4G.
- **Temporary Entry Codes:** Generate time-limited or use-limited codes directly from your phone.
- **Worldwide Timeclock:** Seamlessly schedule entry permissions, keypad settings, and relay functions.
- **Relay Action Snapshots:** Receive instant photo verification when an entry code or trade button is used.
- **Comprehensive Activity Log:** Track all panel events, from calls to relay activations.

Flexible Configuration & Smart Management

Engineered for efficiency, the NX1 simplifies installation and empowers users with advanced control:

- **App-Driven Setup:** Installers can configure the panel in minutes using the Commtel CONFIG app.
- **Ongoing User Control:** End-users enjoy complete management of entry settings and notifications via the Commtel NEXUS app.
- **Push Notifications:** Get real-time alerts for key events, from callpoint presses to triggered inputs.

For a comprehensive list of features, please refer to our product matrix on pages 34 – 37.

Product Specifications

- **Dimensions:** H 216 x W 99 x D 35 mm
- **Faceplate:** Stainless steel with powder-coated black finish
- **Surface Back Boxes:** Moulded aluminium with powder-coated black finish



Commtel NEXUS App

Allows users to see and speak to their visitors, as well as configuring their NX1 and NX250.

commtel.io

NX250



Faceplate Finish



BLACK



Click the icon to learn more about the NX250

The NX250 is Commtel's multi-user IP video intercom, purpose-built for larger residential and commercial sites.

Supporting up to 250 properties and unlimited users, it delivers the same powerful features as the NX1, with the addition of an OLED directory for intuitive visitor navigation. The NX250 provides a robust and scalable solution for modern secure entry.

Advanced Secure Entry

The NX250 combines capacity and convenience with a comprehensive suite of intelligent features:

- **Dual Connectivity:** Choose between Ethernet or 4G for flexible installation and reliable performance.
- **Temporary Entry Codes:** Generate time-limited or use-limited codes directly from your phone.
- **Worldwide Timeclock:** Seamlessly schedule entry permissions, keypad settings, and relay functions.
- **Relay Action Snapshots:** Receive instant photo verification when an entry code or trade button is used.
- **Comprehensive Activity Log:** Track all panel events, from calls to relay activations.

Flexible Configuration & Smart Management

Designed to handle high traffic and multiple users, the NX250 supports installers and residents alike:

- **App-Driven Setup:** Installers can configure the panel in minutes using the Commtel CONFIG app.
- **Ongoing User Control:** End-users enjoy complete management of entry settings and notifications via the Commtel NEXUS app.
- **Push Notifications:** Get real-time alerts for key events, from callpoint presses to triggered inputs.
- **OLED Directory:** Visitors can easily search and call the right property through the integrated display.

For a comprehensive list of features, please refer to our product matrix on pages 34 – 37.

Product Specifications

- **Dimensions:** H 286 x W 126 x D 35 mm
- **Faceplate:** Stainless steel with powder-coated black finish
- **Surface Back Boxes:** Moulded aluminium with powder-coated black finish

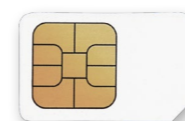

Choose the right SIM.

Discover the Commtel SIM tariff options, detailed on page 32.

+44(0)1306 710 120

SOLO



Faceplate Finish Options

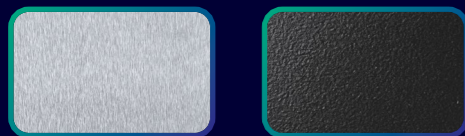

STAINLESS STEEL ANTHRACITE



Click the icon to learn more about the SOLO

Our SOLO intercom delivers reliable access control through essential functionality.

Designed for straightforward communication, the SOLO provides a practical solution for secure entry.

Intelligent Call Management

The SOLO intercom features a built-in time clock that enables intelligent call handling.

- **Flexible Call Diversion:** Easily divert calls to alternative numbers during specified periods, ensuring calls are always answered efficiently.
- **Precise Call Disabling:** If required, the call button can be disabled during designated times, providing enhanced control over when calls are received.

Enhanced Secure entry

The SOLO intercom offers tailored access management and robust security features.

- **Tailored Access Restriction:** Precisely control access by utilising time-restricted authorised dial-to-open numbers, granting entry only to permitted individuals at specified times.
- **Detailed Access Monitoring:** Enhance security and gain peace of mind with the downloadable activity log, which provides a record of entry events.
- **Automated Entry Operation:** The authorised dial-to-open function can be used to automate entry equipment such as gates, barriers, and bollards, allowing for convenient and efficient access during specified hours.
- **Adaptable Keypad Illumination:** Customise the keypad lighting to suit its surroundings by adjusting the brightness or colour as required.

For a comprehensive list of features, please refer to our product matrix on pages 34 – 37.

Product Specifications

- **Dimensions:** H 216 x W 99 x D 35 mm
- **Faceplates:** All faceplates are stainless steel with an option for powder-coated anthracite grey (RAL 7016).
- **Surface Back Box Options:**
 - Moulded aluminium, powder-coated anthracite grey (RAL 7016).
 - 316 Marine grade stainless steel
- **Flush Back Boxes:** Flush back boxes are 316 Marine grade stainless steel.

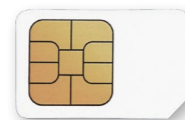

Choose the right SIM.

Discover the Commtel SIM tariff options, detailed on page 32.

Our best-selling SOLO+ intercom system is a focused solution with a built-in keypad.

This single call button intercom solution, like all Commtel intercoms, delivers a wealth of practical benefits and powerful features.

Advanced Secure Entry

The SOLO+'s integrated time clock empowers homeowners and site managers with sophisticated access management.

- **Precise Access Restriction:** Enhance security and enjoy peace of mind by precisely controlling access through time-restricted entry codes and authorised dial-to-open numbers.
- **Automated Entry Operation:** Seamlessly automate the operation of entry equipment such as gates, barriers, and bollards, enabling convenient and efficient access management during specified hours.
- **Intelligent Call Management:** Ensure privacy and optimise call handling by diverting or disabling the call button during designated times.
- **Customisable Keypad Illumination:** Adapt the keypad lighting to suit any environment by customising the brightness or colour based on the time of day.

For a comprehensive list of features, please refer to our product matrix on pages 34 – 37.

Flexible Configuration & Streamlined Management

- **Versatile Hub and Satellite Configuration:** For properties with multiple entry points or where different heights are needed for various vehicles, SOLO+ offers a versatile Hub and Satellite configuration.

(See page 28 for more information).

- **Effortless Remote Access and Programming:** Enables installers to program with ease via the Commtel CONFIG App. Provide end-users with convenient control using the Commtel CONTROL App

(See page 40 for more information).

Product Specifications

- **Dimensions:** H 216 x W 99 x D 35 mm
- **Faceplates:** All faceplates are stainless steel with an option for powder-coated anthracite grey (RAL 7016).
- **Surface Back Box Options:**
 - Moulded aluminium, powder-coated anthracite grey (RAL 7016).
 - 316 Marine grade stainless steel
- **Flush Back Boxes:** Flush back boxes are 316 Marine grade stainless steel.

SOLO+



Faceplate Finish Options

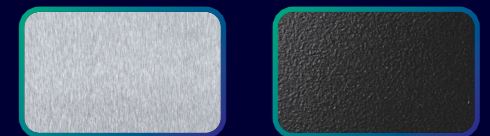

STAINLESS STEEL ANTHRACITE

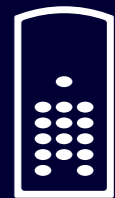

Click the icon to learn more about the SOLO+

DUO+



Faceplate Finish



STAINLESS STEEL



Click the icon to learn more about the DUO+

The DUO+ intercom provides a sleek and compact solution for efficient communication in divided properties or office spaces.

Offering a choice of two call buttons and an integrated keypad as standard, the DUO+ is a cost-effective alternative for applications requiring separate communication at a shared entrance.

Advanced Secure Entry

The DUO+ intercom, like the SOLO+, offers secure and flexible access control

- **Versatile Entry Authorisation:** Authorise entry for specific individuals, such as postal workers or tradespeople, using the built-in keypad and dial-to-open functionality.
- **Precise Timed Access Control:** Manage access effectively and prevent unauthorised entry with the built-in time clock, enabling time restrictions for specific users.

Flexible Configuration

- **Hub and Satellite Configuration:** For sites with multiple entry points or where different mounting heights are required for various vehicles, DUO+ systems offer a versatile Hub and Satellite configuration.

See page 28 for more information.

Product Specifications

- **Dimensions:** H 216 x W 99 x D 35 mm
- **Faceplates:** All faceplates are 316 Marine grade stainless steel.
- **Surface Back Box Options:**
 - Moulded aluminium, powder-coated anthracite grey (RAL 7016).
 - 316 Marine grade stainless steel
- **Flush Back Boxes:** Flush back boxes are 316 Marine grade stainless steel.



Commtel CONTROL App

Allows residents to operate their entry equipment at the push of a button.



Commtel CONFIG App

Simplify setup and management: remotely program all Commtel intercoms with the CONFIG app.

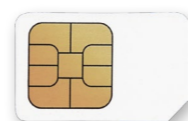

Choose the right SIM.

Discover the Commtel SIM tariff options, detailed on page 32.

The TRIO+ intercom, much like the DUO+, provides a sleek and compact solution for efficient communication in divided properties or office spaces with the benefit of an extra call button.

With three call buttons and an integrated keypad as standard, the TRIO+ continues to be a cost-effective alternative where separate communication at a shared entrance is required.

Advanced Secure Entry

The TRIO+ intercom offers secure and flexible access control

- **Versatile Entry Authorisation:** Authorise entry for specific individuals, such as postal workers or tradespeople, using the built-in keypad and dial-to-open functionality.
- **Precise Timed Access Control:** Manage access effectively and prevent unauthorised entry with the built-in time clock, enabling time restrictions for specific users.

Flexible Configuration

- **Hub and Satellite Configuration:** For sites with multiple entry points or where different mounting heights are required for various vehicles, TRIO+ systems offer a versatile Hub and Satellite configuration.

See page 28 for more information.

Product Specifications

- **Dimensions:** H 216 x W 99 x D 35 mm
- **Faceplates:** All faceplates are 316 Marine grade stainless steel.
- **Surface Back Box Options:**
 - Moulded aluminium, powder-coated anthracite grey (RAL 7016).
 - 316 Marine grade stainless steel
- **Flush Back Boxes:** Flush back boxes are 316 Marine grade stainless steel.

TRIO+



Faceplate Finish



STAINLESS STEEL



Click the icon to learn more about the TRIO+

JUNIOR

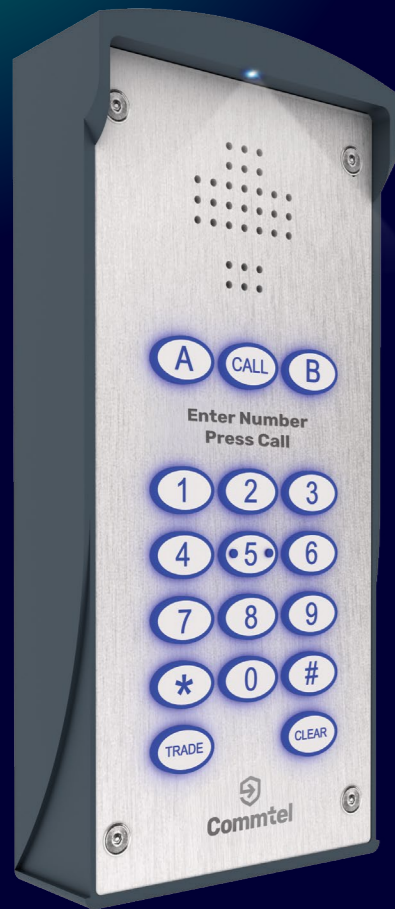

Faceplate Finish Options

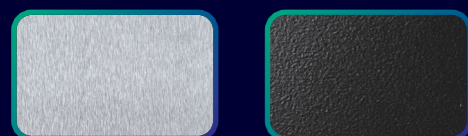

STAINLESS STEEL ANTHRACITE



Click the icon to learn more about the JUNIOR

The JUNIOR intercom is a digital multi-user system designed to serve up to 99 dwellings, providing a practical and convenient solution for visitor management.

This intercom facilitates easy access for both visitors and residents. Visitors can effortlessly contact individual properties by entering the door number followed by 'call', while residents and authorised personnel benefit from secure entry via PIN code.

Like all Commtel products, the JUNIOR is engineered with a range of valuable features to provide residents with convenience, security, and peace of mind.

For a comprehensive list of features, please refer to our product matrix on pages 34 – 37.

Advanced Secure Entry

The JUNIOR intercom offers enhanced and flexible access management.

- **Dial-to-Open Functionality:** Enable authorised entry for specific individuals, such as postal workers or tradespeople, by authorising their mobile number.
- **Timed Access Restriction:** Bolster security by implementing time restrictions for specific users, managed via the built-in time clock.

Flexible Configuration

- **Hub and Satellite Configuration:** For sites with multiple entry points or where varying mounting heights are required for different vehicle types, JUNIOR systems support a versatile Hub and Satellite configuration.

Further details are available on page 28.

Product Specifications

- **Dimensions:** H 216 x W 99 x D 35 mm
- **Faceplates:** All faceplates are stainless steel with an option for powder-coated anthracite grey (RAL 7016).
- **Surface Back Box Options:**
 - Moulded aluminium, powder-coated anthracite grey (RAL 7016).
 - 316 Marine grade stainless steel
- **Flush Back Boxes:** Flush back boxes are 316 Marine grade stainless steel.

Our VARIO intercoms are designed for versatility, adapting to a wide range of applications, from schools, hospitals, and universities to gated communities and individual residential properties.

This systems offer a suite of valuable features, including SMS event alerts, time-restricted access, and downloadable activity logs, providing enhanced security, peace of mind, and streamlined visitor management.

For a comprehensive list of features, please refer to our product matrix on pages 34 – 37.

Configuration options

- Up to 10 individual call buttons.
- Configurations with up to 6 buttons alongside a keypad or access control reader.
- Customisation options with engraving or vinyl labels.

Advanced Secure Entry

VARIO intercoms provide robust and flexible access management.

- **Dial-to-Open Functionality:** Authorise entry for specific individuals, such as postal workers or tradespeople, by authorising their mobile number.
- **Timed Access Restriction:** Enhance security by implementing time restrictions for specific users with our built-in time clock.
- **Access Control Integration:** VARIO systems offer integration with a variety of proximity and Bluetooth readers for expanded access control options.

Flexible Configuration

- **Hub and Satellite Configuration:** For sites with multiple entry points or where different mounting heights are required for various vehicles, VARIO systems offer a versatile Hub and Satellite configuration.

See page 28 for more information.

Product Specifications

- **Dimensions:** H 286 x W 126 x D 40 mm
- **Faceplates:** All faceplates are stainless steel.
- **Surface Back Box:** Moulded aluminium, powder-coated anthracite grey (RAL 7016).
- **Flush Options:** Flush options are available in stainless steel. Please contact our sales team for pricing and dimensions.

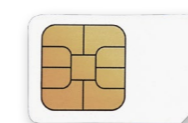

Choose the right SIM.

Discover the Commtel SIM tariff options, detailed on page 32.

VARIO+

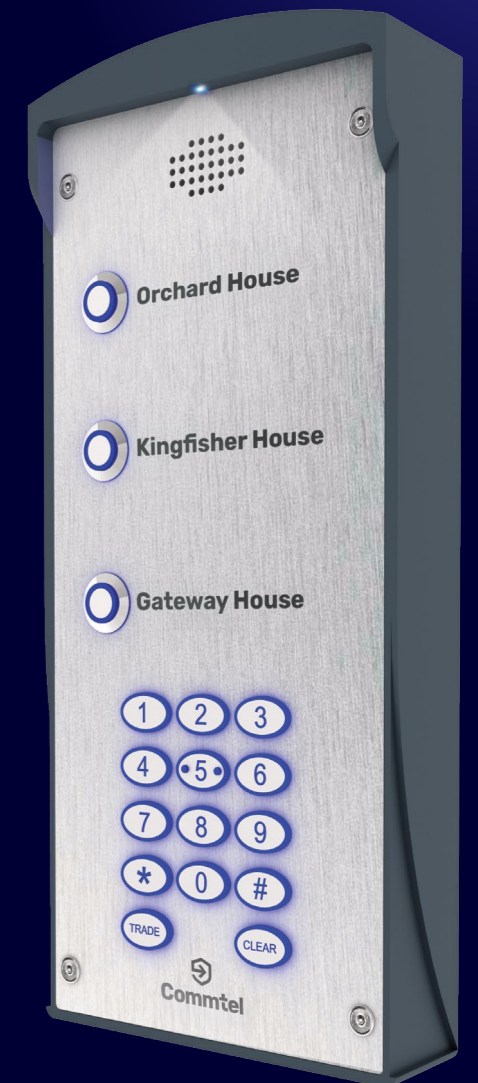

Faceplate Finish

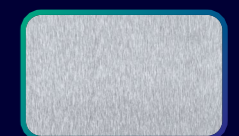

STAINLESS STEEL

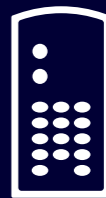

Click the icon to learn more about the VARIO+

MILLENNIUM



Faceplate Finish Options

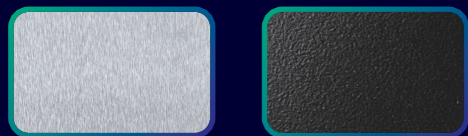

STAINLESS STEEL ANTHRACITE



Click the icon to learn more about the MILLENNIUM

Our MILLENNIUM intercom is a high-capacity solution designed to serve up to 1000 dwellings.

Featuring a user-friendly scrolling OLED directory, the Millennium offers simple and convenient visitor entry, making it an excellent choice for apartment blocks, industrial estates, and large office environments.

Advanced Secure Entry

The MILLENNIUM intercom provides comprehensive and flexible access management.

- **Versatile Entry Authorisation:** Authorise entry for specific individuals using the built-in keypad and dial-to-open functionality.
- **Timed Access Restriction:** Enhance security and control access by implementing time restrictions for specific users with our built-in time clock.
- **Expanded Integration Options:** We offer the integration of proximity and Bluetooth readers, as well as a range of other integration capabilities, including fire switch and biometric integration. (See page 36 for more information).

Flexible Configuration

- **Hub and Satellite Configuration:** For sites with multiple entry points or where different mounting heights are required for various vehicles, MILLENNIUM systems offer a versatile Hub and Satellite configuration.

Further details can be found on page 28.

Product Specifications

- **Dimensions:** H 286 x W 126 x D 35 mm.
- **Faceplates:** All faceplates are stainless steel, with an option for powder-coated anthracite grey (RAL 7016).
- **Surface Back Boxes:** Surface back boxes are moulded aluminium, powder-coated anthracite grey (RAL 7016).
- **Flush Options:** Flush options are available in stainless steel. Contact our sales team for pricing and dimensions.



Commtel CONTROL App

Allows residents to operate their entry equipment at the push of a button.

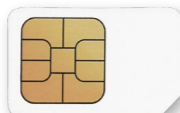

Choose the right SIM.

Discover the Commtel SIM tariff options, detailed on page 32.

The VISION system delivers a powerful combination of voice communication, access control, and video feeds through separate communication pathways.

This unique design ensures both critical access reliability and secure video functionality.

The separation of voice and video calls enhances communication dependability, reducing the possibility of missed visitors, particularly in areas where internet access may be inconsistent for reliable video streaming.

Residents can effortlessly receive video calls via the Commtel VISION app, designed for quick and easy setup and available for download on both iOS and Android devices.

The Vision App is available on both the Android App store and the Apple IOS App store.

For further comprehensive information or to enquire about the VISION, please visit our website or contact our sales team on +44(0)1306 710120 and choose option 2 or alternatively email: sales@commtel.io.

Product Specifications

- **Dimensions:** H 286 x W 126 x D 35 mm.
- **Faceplates:** All faceplates are stainless steel.
- **Surface Back Boxes:** Surface back boxes are moulded aluminium, powder-coated anthracite grey (RAL 7016).
- **Flush Options:** Flush options are available in stainless steel. Contact our sales team for pricing and dimensions.



Commtel CONFIG App

Simplify setup and management: remotely program all Commtel intercoms with the CONFIG app.



Commtel VISION App

Allows residents to view the video feed when receiving a call from one of our Vision panels.

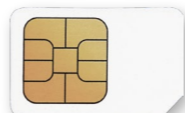

Choose the right SIM.

Discover the Commtel SIM tariff options, detailed on page 32.

VISION



Faceplate Finish

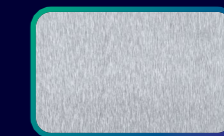

STAINLESS STEEL



Click the icon to learn more about the VISION

SENIOR



Faceplate Finish



STAINLESS STEEL



Click the icon to learn more about the SENIOR

Our SENIOR intercom provides a robust and feature-rich alternative to the MILLENNIUM system.

Featuring a scrolling OLED directory and SMS Event Alerts, the Senior offers enhanced visitor management alongside security and peace of mind for residents.

For a comprehensive list of features, please refer to our product matrix on pages 34 – 37.

Advanced Secure Entry

The SENIOR intercom offers advanced and flexible access management.

- **Versatile Entry Authorisation:** Authorise entry for specific individuals using the built-in keypad and dial-to-open functionality.
- **Timed Access Restriction:** Enhance security and control access by implementing time restrictions for specific users with our built-in time clock.
- **Expanded Integration Options:** We offer the integration of proximity and Bluetooth readers, as well as a range of other integration capabilities.

See page 38 for more information.

Flexible Configuration

- **Hub and Satellite Configuration:** For sites with multiple entry points or where different mounting heights are required for various vehicles, SENIOR systems offer a versatile Hub and Satellite configuration.

Further details can be found on page 28.

Product Specifications

- **Dimensions:** H 286 x W 126 x D 35 mm.
- **Faceplates:** All faceplates are stainless steel, with an option for powder-coated anthracite grey (RAL 7016).
- **Surface Back Boxes:** Surface back boxes are moulded aluminium, powder-coated anthracite grey (RAL 7016).
- **Flush Options:** Flush options are available in stainless steel. Contact our sales team for pricing and dimensions.

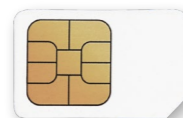

Choose the right SIM.

Discover the Commtel SIM tariff options, detailed on page 32.



Reliable solutions, unwavering support, lasting partnerships.

At Commtel, we believe an entry solution is about more than just technology.

It's about building strong relationships and providing the support you need, every step of the way. That's why we're committed to delivering reliable solutions and working alongside our customers to ensure their success.

Ready to discuss your next project? Contact our sales team for expert advice and tailored solutions.

Call +44(0)1306 710120 - (Option 2) or email sales@commtel.io

HY-CAN HUB

Hubs & Satellites

Commtel's Hubs & Satellites provide a flexible and cost-effective system architecture designed to manage multiple access points from a single location.

In this configuration, Satellites are the intercom units connected to a central Hub. The use of a Hub allows for significant cost savings on network connections, as only a single SIM card or landline/PBX connection is required per Hub.

Hubs enhance security by enabling the core system hardware to be located within a secure area.

Commtel's Hubs and Satellites can be mixed and matched with different Commtel intercom units, making them suitable for a wide range of applications where centralised control of multiple entrances is required, such as sites with multiple buildings, varying access heights for different vehicle types (e.g., cars and lorries), or numerous entry points spread across a large area.

For a comprehensive list of features, please refer to our product matrix on pages 34 – 37.

Key Features

- **Enhanced Security:** Hubs can be located on the secure side of the premises, enhancing overall system security.
- **Cost Efficiency:** Reduce running costs with the need for only a single SIM card or landline/PBX connection per Hub.
- **Flexible Programming:** Enjoy the flexibility to program all Satellites identically or configure them with individual programming parameters to suit specific needs.

Configuration Options

The optimal setup will vary depending on the specific location and usage requirements. Options include:

- Choice of either a 4G or analogue Hub.
- Support for up to 4 Satellites without a display.

OR

- Support for up to 3 Satellites with a display.

*Cabling is required between the Hub and Satellites.

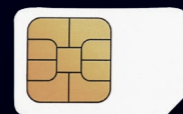

Choose the right SIM.

Discover the Commtel SIM tariff options, detailed on page 32.

Up to a maximum of three Millennium **OR** three Senior units.

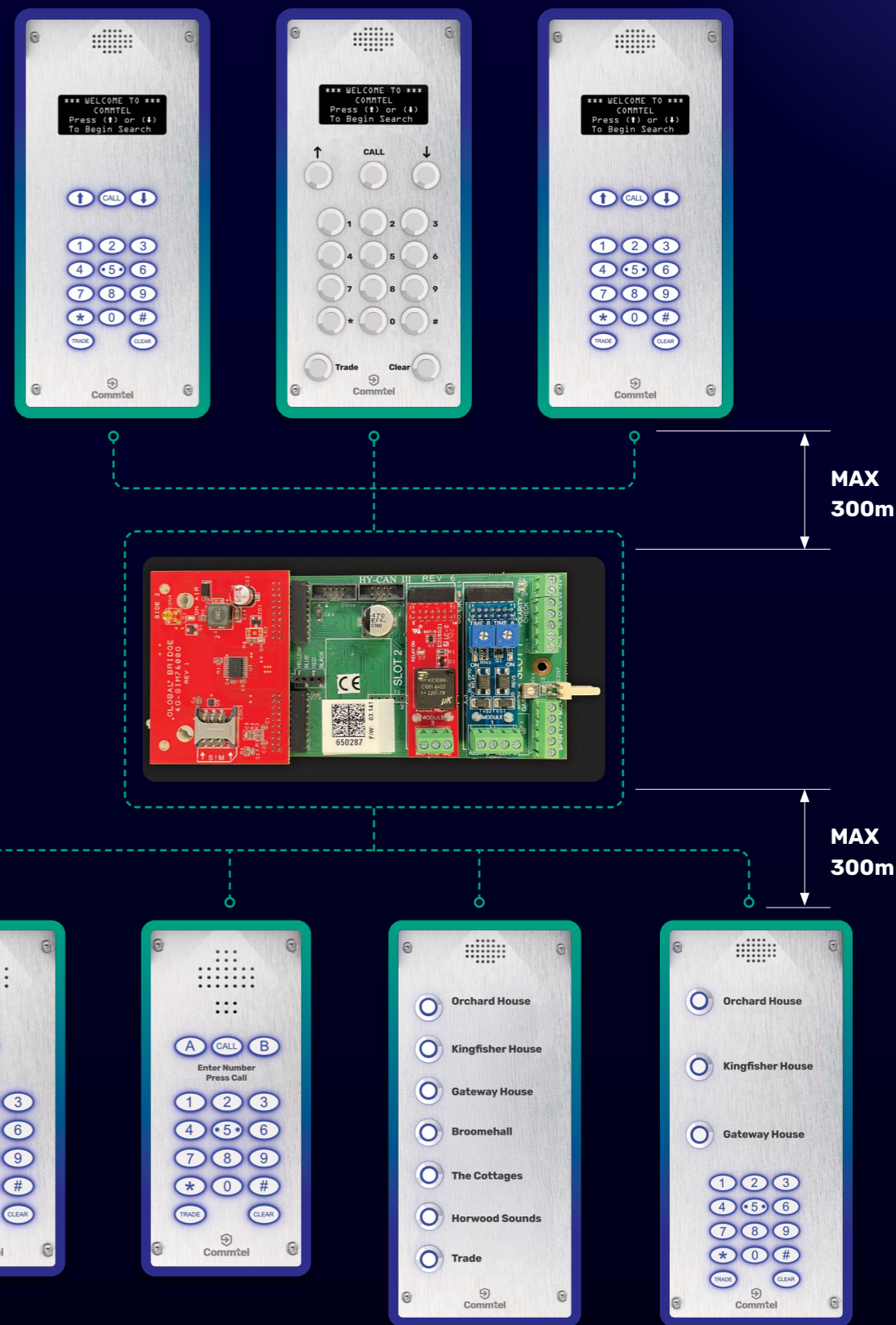

OR up to four SOLO / SOLO+ / DUO+ / TRIO+ / JUNIOR / VARIO.

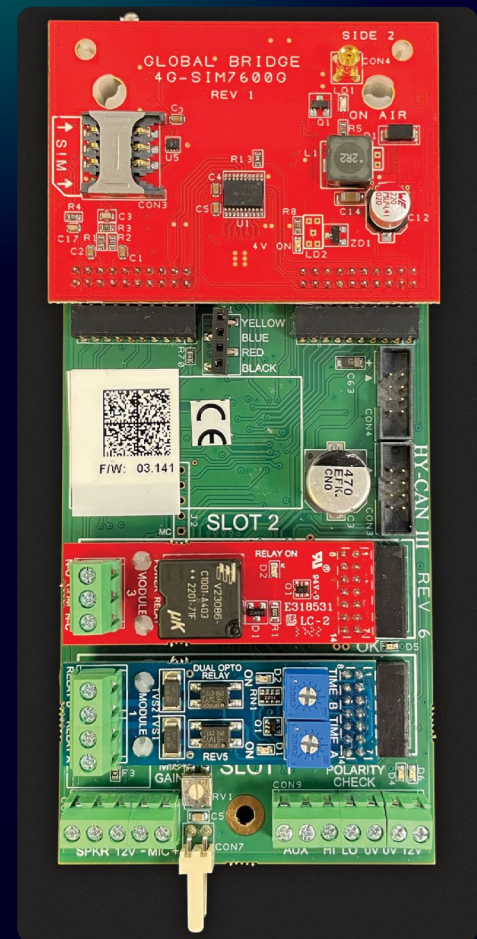

Commtel CONFIG App

Simplify setup and management: remotely program all Commtel intercoms with the CONFIG app.

TELPAD II

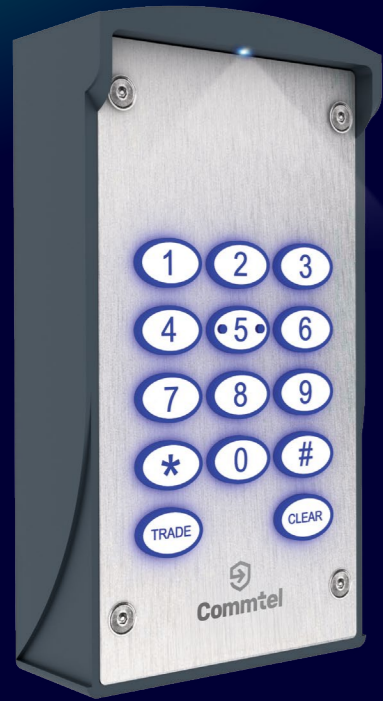

Faceplate Finish Options

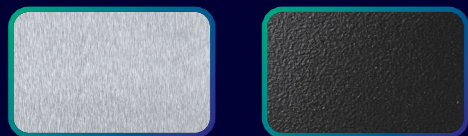

STAINLESS STEEL ANTHRACITE



Click the icon to learn more about the TELPAD II

The Telpad II enhances access control when paired with any Commtel intercom or Hub, providing secure keypad entry in situations where audio communication at the entrance is not required.

A key advantage of the Telpad II over standalone keypads lies in its remote programming capability. Eliminate the need for manual entry code management and simplify access control administration using our Commtel CONFIG app

(See page 40 for more information).

The Telpad II also leverages the intelligent, built-in features of the connected system, such as the time clock and activity logs. Furthermore, on-board SMS notifications can be programmed to alert you of any activity.

For a comprehensive list of features, please refer to our product matrix on pages 34 – 37.

Key Features

- **Remote Programming:** Program the Telpad II remotely via a connected Commtel intercom or Hub.
- **Timed PIN Codes:** Implement time-restricted access control using timed entry codes.
- **Event Alerts:** Receive notifications of access events with programmable event alerts.
- **Activity Log:** Review a log of events and enhance security with the integrated activity log.

Versatile Application

The Telpad II can be utilised as an entry or exit keypad for various applications, including:

- Doors
- Gates
- Turnstiles
- Barriers
- Bollards

Product Specifications

- **Dimensions:** H 166 x W 89 x D 35 mm
- **Faceplates:** All faceplates are stainless steel with an option for powder-coated anthracite grey (RAL 7016).
- **Surface Back Boxes:** Surface back boxes are moulded aluminium, powder-coated anthracite grey (RAL 7016).

The Commtel Command Unit is our advanced 4G switch, the next generation of remote access technology evolving from our original GSM Dialler.

Programmed and controlled with ease via the CU Companion app, the Command Unit provides simple, hassle-free, and reliable remote entry and control of any powered entrance using the 4G network.

For a comprehensive list of features, please refer to our product matrix on pages 34 – 37.

Key Features

- **Connectivity:** 1 x Auxiliary Input, 1 x Relay Output
- **Enhanced Access Control:** Authorise access for up to 1300 users, enabling door or gate operation with a simple call – a modern and cost-effective alternative to traditional access control systems.
- **Integrated Time Management:** The built-in time clock facilitates timed entry, providing precise control over access permissions.
- **Activity Logging:** Review a log of events and enhance security with the integrated activity log.

Streamlined Management

- Effortless Remote Access and Programming:
- Installers can program and configure the unit with ease via the Commtel CONFIG App.
- End-users benefit from convenient control through the CU COMPANION App.

(See page 40 for more information).



Commtel CONFIG App

Simplify setup and management: remotely program all Commtel intercoms with the CONFIG app.



Commtel CU COMPANION App

Allows users to programme and control the Command Unit system using the CU COMPANION app.

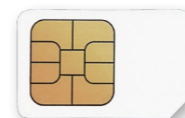

Choose the right SIM.

Discover the Commtel SIM tariff options, detailed on page 32.

COMMAND UNIT

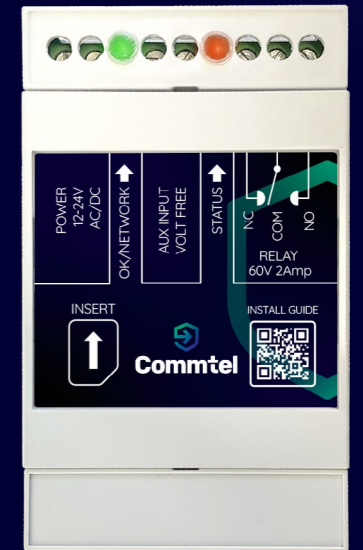

Click the icon to learn more about the COMMAND UNIT

SIM CARDS

In today's connected world, selecting the appropriate SIM card is essential for the reliable operation of your Commtel intercom system.

However, with the abundance of network providers and diverse tariffs available, it can be challenging to determine the optimal choice.

The complexity arises from the fact that most SIM cards are designed primarily for use in mobile phones, not in static machines like intercoms, which have distinct requirements. Therefore, careful consideration must be given to ensure the SIM card you select is truly fit for purpose.

Key Considerations

Several factors differentiate intercom SIM card requirements from those of mobile phones. Intercoms are often installed in locations with varying signal strengths, including those that may be challenging for standard mobile devices.

They may also be subject to environmental factors that mobile phones typically avoid. Furthermore, intercoms require consistent, reliable connectivity for critical communication functions, unlike the more intermittent usage patterns of a mobile phone.

These distinctions highlight the importance of choosing a SIM card and tariff specifically suited to the demands of your Commtel intercom system.

Choosing the Right SIM

Network Coverage: Selecting a SIM card on the best network in the area is key. We recommend using a signal analyser to get an accurate signal reading at the intercom's antenna location.

SMS & MMS Marketing: Most SIM cards for mobile phones receive marketing messages, which can cause abnormal behaviour in intercoms. Contact the network provider to disable these messages.

Our Tariffs

At Commtel, we believe in empowering our customers with control over their billing.

That's why we offer both flexible pay-monthly tariffs and streamlined pay-annually plans, designed to accommodate diverse financial preferences and operational requirements.



Our Pay Monthly options

Essential Tariffs (Pay-Monthly):

Recommended for single dwelling residential properties, Command Units, diallers, or low-use commercial sites.

- **Networks: O2 or Vodafone**
- **£4.50** monthly fee (subject to VAT)*
- 100 minutes to UK numbers (calls up to 60 seconds)
- 100 texts to UK numbers (for SMS text alerts and programming confirmation responses)
- 100MB data included (for remote programming)**
- 30-day rolling contract.

Data Tariffs (Pay-Monthly):

Our monthly data SIM offers reliable, multi-network connectivity on a 30-day rolling contract, giving flexibility without long-term commitment.

- **Multi-Networks: Covering O2, Vodafone & EE**
- **£7.50** monthly fee (subject to VAT)*
- 1GB data included
- 30-day rolling contract.

Unlimited Tariffs (Pay-Monthly):

Recommended for multi-dwelling residential properties (e.g., apartment blocks) or high-use commercial sites (e.g., buildings, industrial estates, schools).

- **Networks: O2 or Vodafone**
- **£16** monthly fee (subject to VAT)*
- Unlimited calls to UK numbers
- Unlimited texts to UK numbers
- 100MB data included**
- 30-day rolling contract.

Our Pay Annually option

Unlimited Annual Tariffs (Pay-Annually):

Ideal for sites unable to set up a monthly direct debit. Recommended for multi-dwelling residential properties (e.g., apartment blocks) or high-use commercial sites (e.g., buildings, industrial estates, schools).

- **Networks: O2 or Vodafone**
- **£192** annual fee (subject to VAT)*
- Unlimited calls to UK numbers
- Unlimited texts to UK numbers
- 100MB data included**
- Annual contract (upfront payment required).

*All prices quoted are subject to VAT at the current rate and are subject to change.

**A small amount of data is used for programming when done remotely using our software.

Data Tariffs (Pay-Annually):

Our annual data SIMs provide reliable, multi-network connectivity with a single upfront payment, keeping ongoing management simple and predictable.

- **Multi-Networks: Covering O2, Vodafone & EE**
- **£90** annual fee (subject to VAT)*
- 1GB data included



For assistance in selecting the most suitable SIM card for your Commtel system, please click the icon, or contact our sales team: call **+44(0)1306 710120** - (Option 2) or email sales@commtel.io

PRODUCT MATRIX



NX1

NX250

SOLO

SOLO+

DUO+

TRIO+

JUNIOR

PRODUCT CODES:
NX1

PRODUCT CODES:
NX250

PRODUCT CODES:
4G: ML4SO
SATELLITE: SMLSO

PRODUCT CODES:
4G: ML4SO+
SATELLITE: SMLSO+

PRODUCT CODES:
4G: ML2+
SATELLITE: SML2+

PRODUCT CODES:
4G: ML3+
SATELLITE: SML3+

PRODUCT CODES:
4G: ML4TJ
SATELLITE: SMLTJ

Connectivity	4G - IP	4G - IP	4G	4G	4G	4G	4G
Number of Users / Number of Call Buttons	1	250	1	1	2	3	99
User Capacity	500	1000	-	-	-	-	-
Call Forwarding	6	6	7	7	7	7	7
Access Codes	1500	15000	-	400	400	400	400
Temporary Codes	Y	Y	-	Y	Y	Y	Y
Authorised Dial-To-Open	1500 *	15000 *	1300	1300	1300	1300	1300
Relay Outputs Supplied	3	3	3	3	3	3	3
Auxiliary Inputs	2	2	2	2	2	2	2
Activity Log	Y	Y	Y	Y	Y	Y	Y
Push Notifications	Y	Y	-	-	-	-	-
Internal Time Clock with Time Profiles	Y	Y	Y	Y	Y	Y	Y
Programmable Backlit OLED Display	-	Y	-	-	-	-	-
Timed Trade Button	Y	Y	-	Y	Y	Y	Y
SMS Alerts	-	-	Y	Y	Y	Y	Y
Option for Anthracite Faceplate	-	-	-	Y	-	-	Y
Option for Flush Mounting (Stainless Steel Only)	-	-	Y	Y	Y	Y	Y
Programmable via App	Y	Y	Y	Y	Y	Y	Y

* SIP Subscription required, find out more in the product user guide, downloadable on our website

Our supportive sales team is ready to assist you with solving your secure entry needs. Call **+44(0)1306 710120** - (Option 2) or email sales@commtel.io

PRODUCT MATRIX



VARIO/VARIO+

PRODUCT CODES:
4G: 4BD(X) / 4BDC(X)
SAT: SBD(X) / SBDC(X)

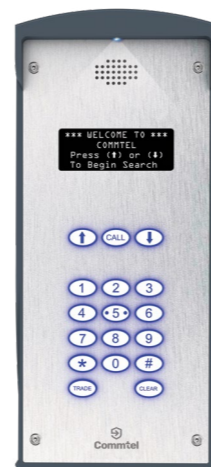

MILLENNIUM

PRODUCT CODES:
4G: 4BDTM
SATELLITE: SBDTM



VISION

PRODUCT CODES:
4G: 6BDM



SENIOR

PRODUCT CODES:
4G: 4BDTS
SATELLITE: SBDTS



HUB

PRODUCT CODES:
4G: 4TH
LANDLINE: LTH



TELPAD II

PRODUCT CODES:
TTP2



COMMAND UNIT

PRODUCT CODES:
4TGPU

Connectivity	4G	4G	4G	4G	4G / Landline	-	4G
Number of Users / Number of Call Buttons	2-10 / 1-6	1000	1000	1000	-	-	-
User Capacity	-	-	-	-	-	-	-
Call Forwarding	7	7	7	7	-	-	-
Access Codes	NA / 400	400	400	400	-	400 *	-
Temporary Codes	Y	Y	Y	Y	-	Y *	-
Authorised Dial-To-Open	1300	1300	1300	1300	-	1300 **	1300
Relay Outputs Supplied	3	3	3	3	3	-	1
Auxiliary Inputs	2	2	2	2	1	-	1
Activity Log **	Y	Y	Y	Y	Y	As per connected unit	Y
Push Notifications	-	-	-	-	-	-	-
Internal Time Clock with Time Profiles	Y	Y	Y	Y	Y	As per connected unit	Y
Programmable Backlit OLED Display	-	Y	Y	Y	-	-	-
Timed Trade Button	N / Y	Y	Y	Y	-	Y	-
SMS Alerts	Y	Y	Y	Y	Y	Y *	Y
Option for Anthracite Faceplate	-	Y	-	-	-	Y	-
Option for Flush Mounting (Stainless Steel Only)	-	-	-	-	-	-	-
Programmable via App	Y	Y	Y	Y	Y	As per connected unit	Y

* Shared with connected Commtel unit.

** This is available by a request from our Technical Support Team

Our supportive sales team is ready to assist you with solving your secure entry needs. Call **+44(0)1306 710120** - (Option 2) or email sales@commtel.io

CUSTOM SOLUTIONS

Commtel understands that every project presents unique challenges. That's why we offer fully customisable intercom solutions.

Going beyond standard offerings, we collaborate with you to create tailored systems that seamlessly integrate into your project design and deliver optimal functionality.

We can accommodate site-specific dimensions to ensure perfect integration, and offer variable button configurations with up to 100 buttons for large-scale or complex applications. Tailored button layouts optimise the user experience, while personalised aesthetics are achievable through engraving and a variety of finishes.

To enhance accessibility, we can integrate a Hearing Aid Induction Loop. Furthermore, we provide the option for expanded functionality with cut-outs to house proximity readers, Bluetooth readers, biometrics, fire switches, and cameras.

Our supportive sales team is ready to assist you with your custom intercom needs.

Call +44(0)1306 710120 - (Option 2).



YOUR VISION. Our Expertise.

At Commtel, we understand that off-the-shelf solutions don't always meet the unique demands of every project. That's why we offer extensive customisation options, allowing you to create secure entry systems that perfectly align with your vision.

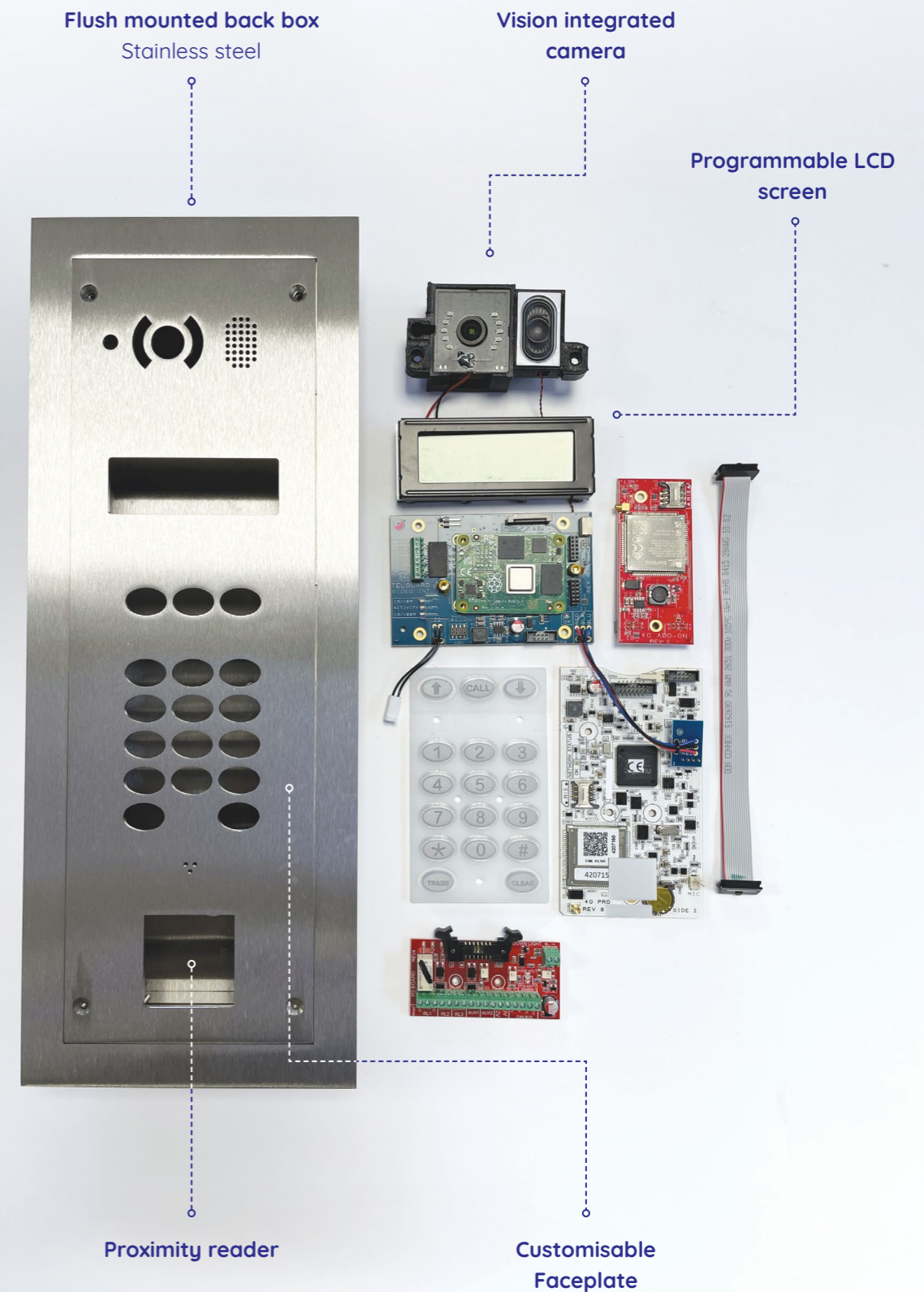

We know your time is valuable. That's why we have created a suite of intuitive, user-friendly apps designed to give you complete control from the palm of your hand.

Our apps are a direct extension of our commitment to seamless, user-centric solutions. They simplify every stage of the process, from a quick and easy setup to ongoing management and seamless operation.

With tools that make installation faster and features that give end-users effortless control, we're providing the support you need, when you need it most.

We don't just build products; we build solutions that work for you.



You can download the Commtel apps for free, from either the Android or iOS app stores.

INSTALLER PROGRAMMING APP

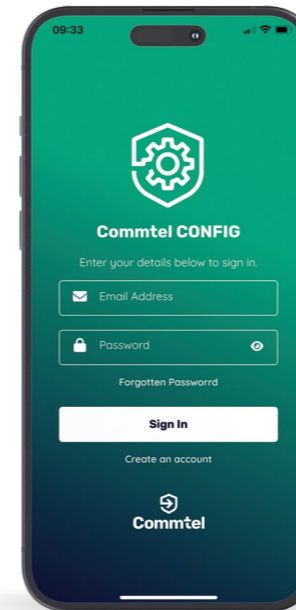

Commtel CONFIG App

The Commtel CONFIG app makes it quick and easy to program and manage your Commtel intercoms or your Command Unit.

For user instructions within the app, you can click on the help icon in the top right of the screen.

[Download the Commtel CONFIG User Guide](#)

END-USER APPS

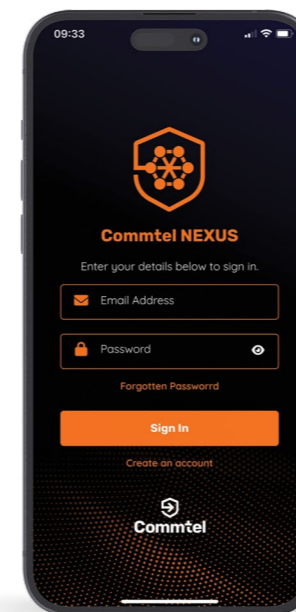

Commtel NEXUS

Allows users to see and speak to their visitors, as well as configuring their NX1 and NX250 intercoms.



Commtel CU COMPANION

Lets users control and configure their Command Unit using simple SMS commands.

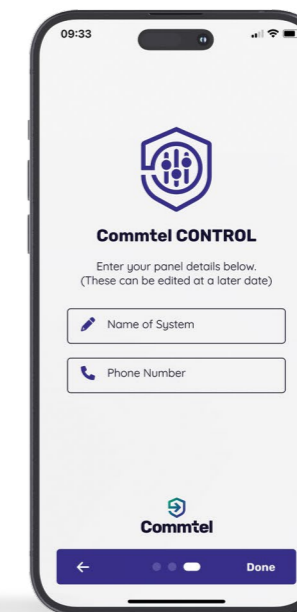

Commtel CONTROL

Control your Commtel systems using simple SMS commands.

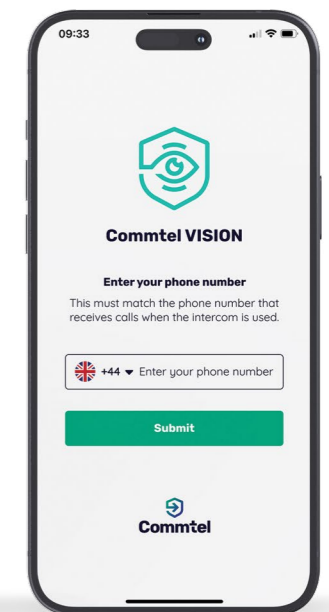

Commtel VISION

Allows users to view the video feed when receiving a call from the Vision intercom.

Commtel Ltd.

ORCHARD HOUSE, 39 GATWICK ROAD
CRAWLEY, WEST SUSSEX RH10 9RB

 +44 (0) 1306 710120

 sales@commtel.io

 www.commtel.io



Cert No. 12535
ISO 27001



Raising Standards
Advancing Safety

